

● General Description

Through advanced trench and field stop technology to provide very low $V_{CE(sat)}$, low gate charge, and excellent switching performance.

● Features

- Very low $V_{CE(sat)}$
- Low switching power loss
- Low switching surge and noise
- Low thermal resistance
- High short circuit capability (10us)
- AEC-Q101 qualified

● Application

- PTC Heater



● Product Summary

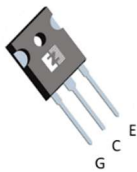

TO-247

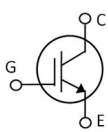

$V_{CE}=750V$

$V_{CE(sat)}=1.55V$

$I_C=40A$



● Ordering Information

Part NO.	ZMBGA40N075S1AC
Marking	BG40N075S1A
Packing information	TUBE BULK
Basic ordering unit (pcs)	600

● Absolute Maximum Ratings ($T_A=25^{\circ}C$, unless otherwise specified)

Parameter	Symbol	Conditions	Min.	Max.	Unit
Collector-emitter voltage	V_{CE}		-	750	V
Gate-emitter voltage	V_{GE}		-30	30	V
Continuous collector current	I_C	$V_{GE}=15V, T_C=25^{\circ}C$	-	80	A
	I_C	$V_{GE}=15V, T_C=100^{\circ}C$	-	40	A
Pulsed collector current	I_{CM}	Pulsed; $t_p \leq 10 \mu s; T_C = 25^{\circ}C$;	-	160	A
Total power dissipation	P_D	$T_C=25^{\circ}C$	-	357	W
Total power dissipation	P_D	$T_A=25^{\circ}C$	-	3.8	W
Short circuit withstand time	T_{sc}	$V_{GE}=15 V, V_{CE}=400 V, T_J=150^{\circ}C$	-	10	us
Operating junction temperature	T_J		-55	175	$^{\circ}C$
Storage temperature	T_{STG}		-55	175	$^{\circ}C$

● Thermal resistance

Parameter	Symbol	Min.	Typ.	Max.	Unit
Thermal resistance, junction - case	R_{thJC}	-	-	0.42	°C/W
Thermal resistance, junction - ambient	R_{thJA}	-	-	40	°C/W
Soldering temperature (total time<10s)	T_{sold}	-	-	260	°C

 ● Electronic Characteristics ($T_j=25^{\circ}\text{C}$, unless otherwise specified)

Parameter	Symbol	Condition	Min.	Typ.	Max.	Unit
Collector-emitter breakdown voltage	BV_{CES}	$V_{GE}=0V, I_C=250\mu A$	750	-	-	V
Gate-emitter threshold voltage	$V_{GE(th)}$	$V_{GE}=V_{CE}, I_C=1.5mA$	4.7	5.7	6.4	V
Zero gate voltage collector current	I_{CES}	$V_{GE}=0V, V_{CE}=400V, T_j=25^{\circ}\text{C}$	-	-	10	μA
		$V_{GE}=0V, V_{CE}=400V, T_j=175^{\circ}\text{C}$	-	-	10	mA
Gate-emitter leakage current	I_{GES}	$V_{GE}=\pm 30V, V_{CE}=0V$	-	-	100	nA
Collector-emitter saturation voltage	$V_{CE(sat)}$	$V_{GE}=15V, I_C=40A, T_j=25^{\circ}\text{C}$	-	1.55	2	V
		$V_{GE}=15V, I_C=40A, T_j=175^{\circ}\text{C}$	-	2	-	V
Forward transconductance	g_{FS}	$V_{CE}=20V, I_C=40A$	-	15	-	S

 ● Dynamic characteristics ($T_j=25^{\circ}\text{C}$, unless otherwise specified)

Parameter	Symbol	Condition	Min.	Typ.	Max.	Unit
Input capacitance	C_{ies}	$f=100\text{KHz}, V_{CE}=400V, V_{GE}=0V$	-	3509	-	pF
Output capacitance	C_{oes}		-	45	-	pF
Reverse transfer capacitance	C_{res}		-	16	-	pF
Gate resistance	R_g	$f=1\text{MHz}$	-	3.4	-	Ω
Total gate charge	Q_g	$V_{CC}=400V, I_C=40A, V_{GE}=15V$	-	112.8	-	nC
Gate-emitter charge	Q_{ge}		-	33.8	-	nC
Gate-collector charge	Q_{gc}		-	46.2	-	nC

 ● Switching characteristics ($T_j=25^{\circ}\text{C}$)

Parameter	Symbol	Condition	Min.	Typ.	Max.	Unit
Turn-on delay time	$t_{d(on)}$	$T_j=25^{\circ}\text{C}$	-	43	-	ns
Turn-on rise time	t_r	$V_{GE}=15/0V,$	-	47	-	ns
Turn-off delay time	$t_{d(off)}$	$V_{CE}=400V,$	-	109	-	ns
Turn-off fall time	t_f	$R_G=6.2\Omega,$	-	23	-	ns
Turn-on energy	E_{on}	$I_C=40A,$	-	1.25	-	mJ
		$L=100\mu H$				

Turn-off energy	E_{off}		-	0.61	-	mJ
Total switching energy	E_{ts}		-	1.86	-	mJ
Reverse Bias Safe Operating Area	RBSOA	$T_j=25^{\circ}\text{C}, V_{CC}=750\text{V},$ $I_C=160\text{A},$ $V_{GE}=15\text{V}/0\text{V}, R_g=10\Omega$	Full Square			-

● Switching characteristics ($T_j=175^{\circ}\text{C}$)

Parameter	Symbol	Condition	Min.	Typ.	Max.	Unit
Turn-on delay time	$t_{d(on)}$	$T_j=175^{\circ}\text{C}$ $V_{GE}=15/0\text{V},$ $V_{CE}=400\text{V},$ $R_G=6.2\Omega,$ $I_C=40\text{A},$ $L=100\mu\text{H}$	-	41	-	ns
Turn-on rise time	t_r		-	50	-	ns
Turn-off delay time	$t_{d(off)}$		-	122	-	ns
Turn-off fall time	t_f		-	47	-	ns
Turn-on energy	E_{on}		-	1.39	-	mJ
Turn-off energy	E_{off}		-	0.91	-	mJ
Total switching energy	E_{ts}		-	2.3	-	mJ

● Fig.1 Gate-emitter voltage as a function of gate charge; Typical values; $T_j=25^\circ\text{C}$

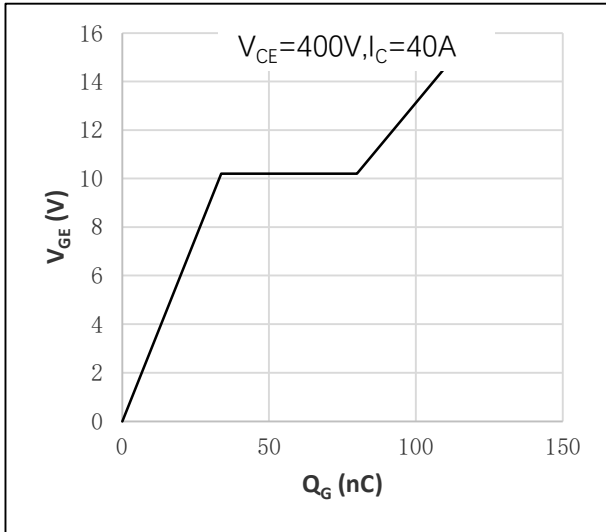

● Fig.2 Input, output and reverse transfer capacitances as a function of collector-emitter voltage; Typical values; $T_j=25^\circ\text{C}$

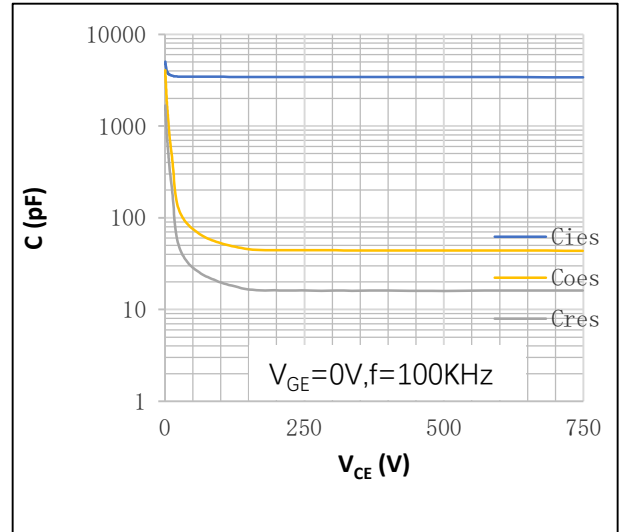

● Fig.3 Output characteristics: collector current as a function of collector-emitter voltage; Typical values; $T_j=25^\circ\text{C}$

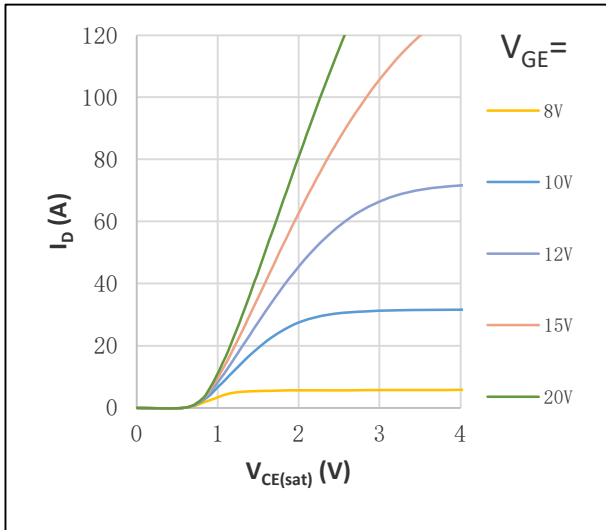

● Fig.4 Output characteristics: collector current as a function of collector-emitter voltage; Typical values: Expanded curve; $T_j=25^\circ\text{C}$

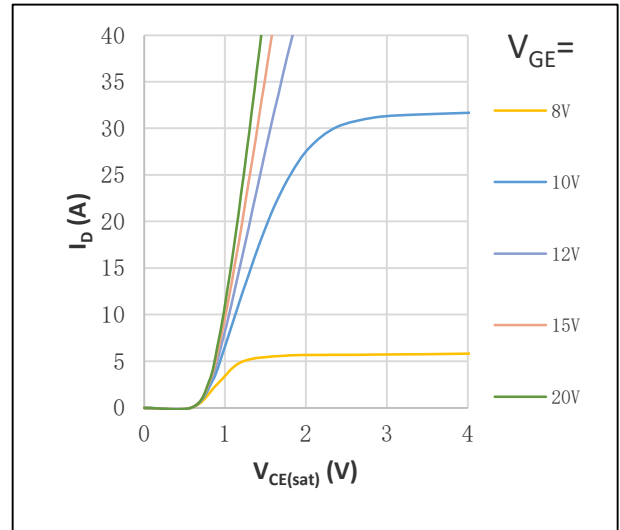

● Fig.5 Gate-emitter threshold voltage as a function of junction temperature; Typical values

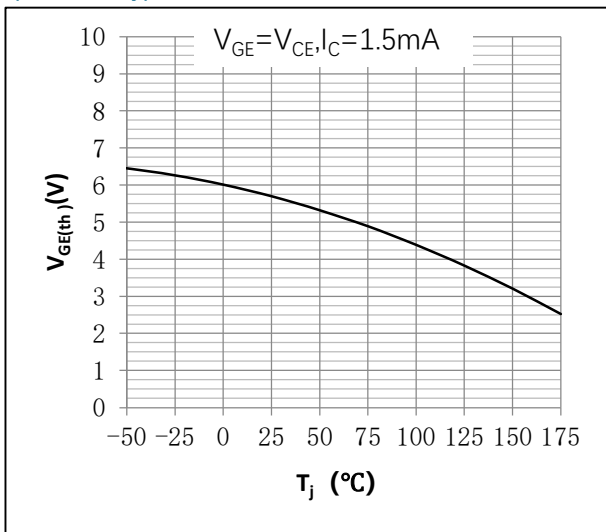

● Fig.6 Continuous collector current as a function of case temperature¹; Calculative values

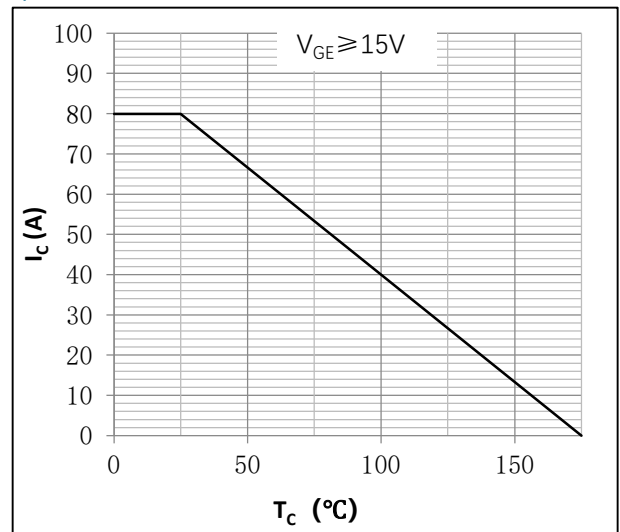

● Fig.7 Collector-emitter saturation voltage as a function of gate-emitter voltage; Typical values

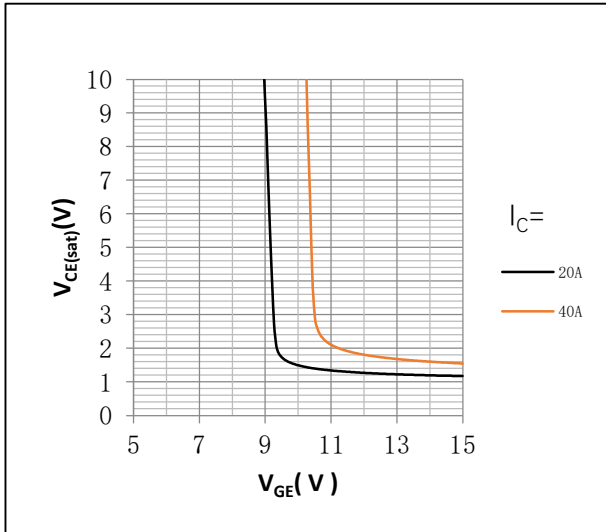

● Fig.8 Fig.6 Collector-emitter saturation voltage as a function of junction temperature; Typical values; $T_j=25^\circ C$

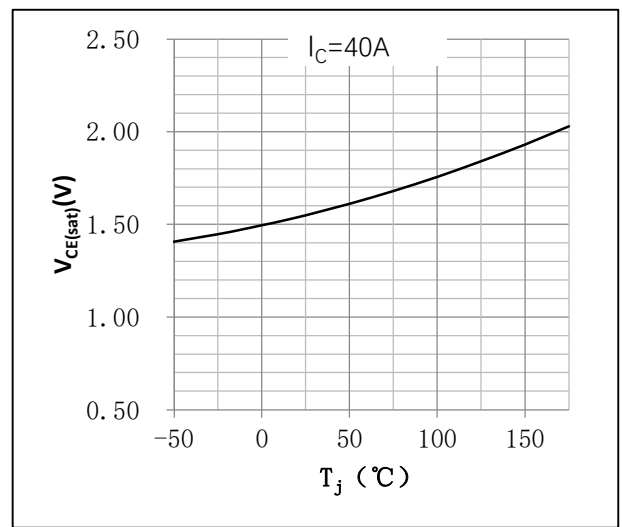

● Figure 9. Normalized total power dissipation as a function of case temperature; Calculative values Normalized Power Dissipation = $P_d/P_d(25^\circ C)$

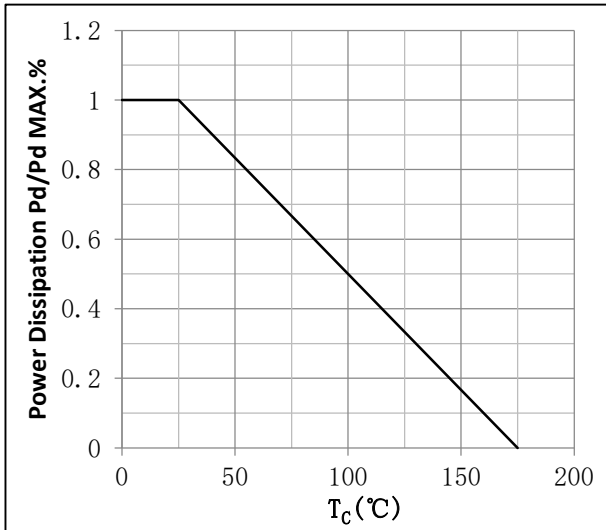

● Figure 10. Transfer characteristics: Collector current as a function of gate-emitter voltage; Typical values

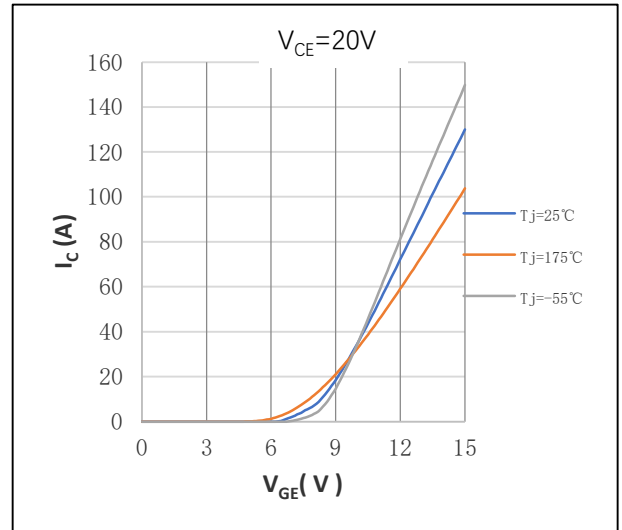

● Fig.11 Safe operating area: continuous and peak collector currents as a function of collector-emitter voltage; Calculative values

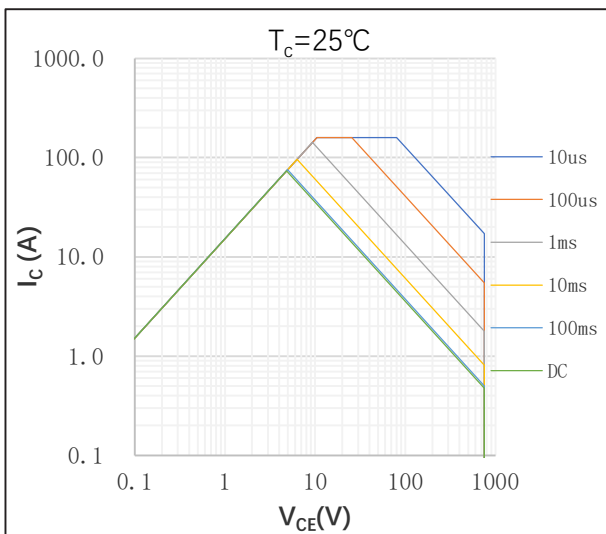

● Fig.12 Reverse bias safe operating area: peak collector currents as a function of collector-emitter voltage; Calculative values

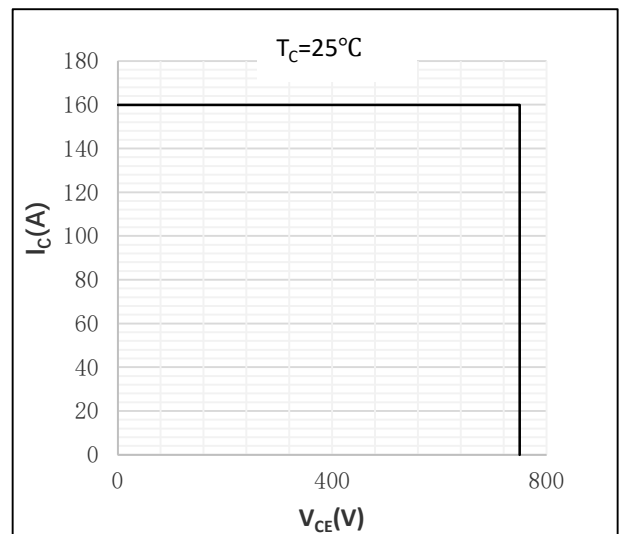

● Fig.13 Transient thermal impedance from junction to case as a function of pulse duration; max values

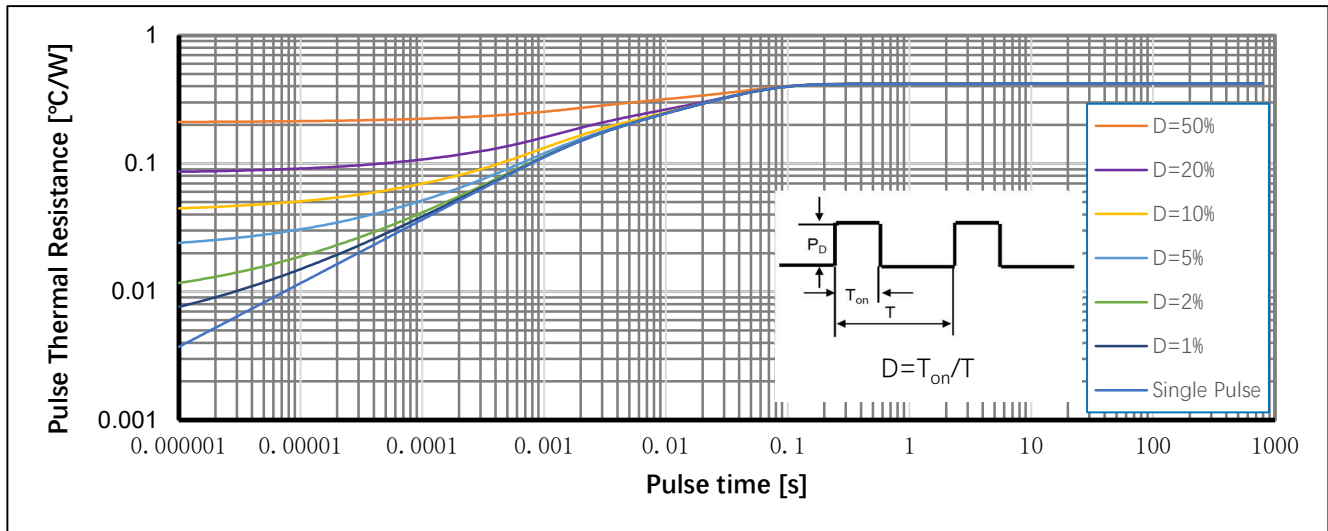

● Package Outline

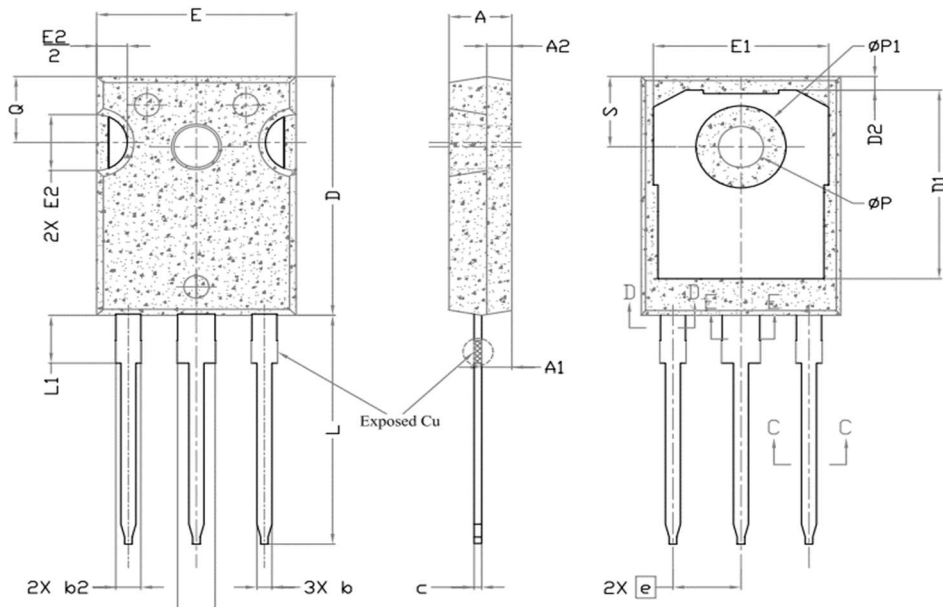

SYMBOL	DIMENSIONS			NOTES
	MIN.	NOM.	MAX.	
A	4.83	5.02	5.21	
A1	2.29	2.41	2.55	
A2	1.50	2.00	2.49	
b	1.12	1.20	1.33	
b1	1.12	1.20	1.28	
b2	1.91	2.00	2.39	6
b3	1.91	2.00	2.34	
b4	2.87	3.00	3.22	6, 8
b5	2.87	3.00	3.18	
c	0.55	0.60	0.69	6
c1	0.55	0.60	0.65	
D	20.80	20.95	21.10	4
D1	16.25	16.55	17.65	5
D2	0.51	1.19	1.35	
E	15.75	15.94	16.13	4
E1	13.46	14.02	14.16	5
E2	4.32	4.91	5.49	3
e	5.44BSC			
L	19.81	20.07	20.32	
L1	4.10	4.19	4.40	6
ØP	3.56	3.61	3.65	7
ØP1	7.19REF.			
Q	5.39	5.79	6.20	
S	6.04	6.17	6.30	

● Note

① Practically the current will be limited by PCB, thermal design and operating temperature. $V_{GE}=15V$.

● Disclaimer

- Reproducing and modifying information of the document is prohibited without permission from ZMJ SEMICONDDUCTORS CO., LTD.
- ZMJ SEMICONDDUCTORS CO., LTD. reserves the rights to make changes of the content herein the document anytime without notification. Please refer to our website for the latest document.
- ZMJ SEMICONDDUCTORS CO., LTD. disclaims any and all liability arising out of the application or use of any product including damages incidentally and consequentially occurred.
- ZMJ SEMICONDDUCTORS CO., LTD. does not assume any and all implied warranties, including warranties of fitness for particular purpose, non-infringement and merchantability.
- Applications shown on the herein document are examples of standard use and operation. Customers are responsible in comprehending the suitable use in particular applications. ZMJ SEMICONDDUCTORS CO., LTD. makes no representation or warranty that such applications will be suitable for the specified use without further testing or modification.
- The products shown herein are not designed and authorized for equipments relating to human life and for any applications concerning life-saving or life-sustaining, such as medical instruments, aerospace machinery et cetera. Customers using or selling these products for use in such applications do so at their own risk and agree to fully indemnify ZMJ SEMICONDDUCTORS CO., LTD. for any damages resulting from such improper use or sale.
- Since ZMJ uses lot number as the tracking base, please provide the lot number for tracking when complaining.

● Revision History

Version	Date	Change
A	2026/2/27	New